

Varenummer: 03553050

Beskrivelse: Fluro hydraulik ledhoved FPR 50U

Mål

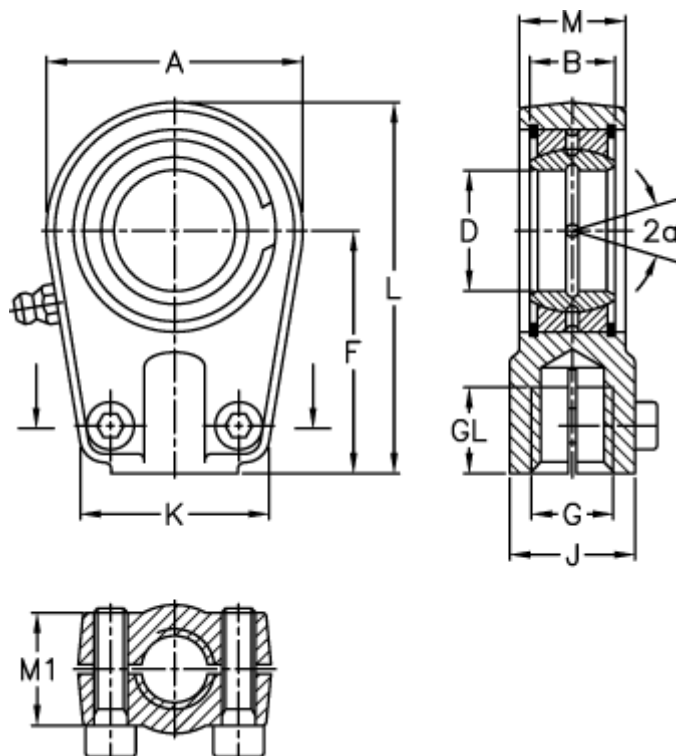

A	= 116	J	= 61
a (grader)	= 6	K	= 90
B	= 35	L	= 168
D	= 50	M	= 40
Dynamisk belastning C (kN)	= 156	M1	= 37
F	= 105	Moment (Nm)	= 86
g	= M45x1,5	Statisk belastning C0 (kN)	= 365
GL	= 46	Vægt	= 3575